

# DragonROV

Intelligent Subsea Equipment

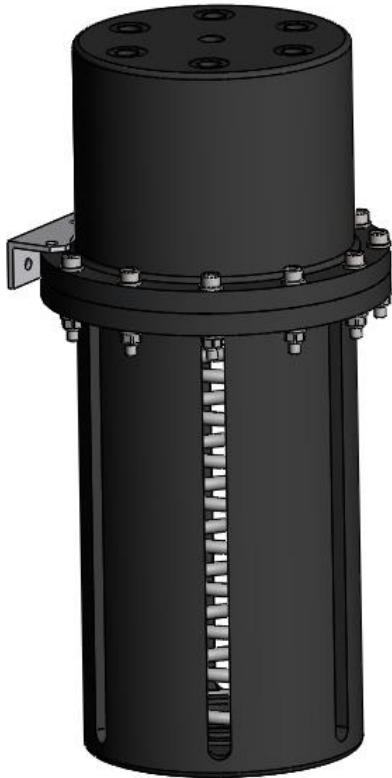

## Description:

Rolling bladder type compensator for pressure balancing of subsea oil filled assemblies such as junction boxes, transformer housings, or motor bodies. Standard design manufactured from lightweight corrosion resistant Acetal for general purpose use.

## Hydraulic Compensator 2770cc version

### MAIN FEATURES

- Corrosion resistant
- 2770cc volume
- Compensates a volume of up to 18490cc
- Acetal body with rubber diaphragm and stainless steel spring

### Further Information

Advanced spares kits also available

### Equipment supplied

Standard supply includes

- 2770cc compensator unit.
- Operating manual



info@DragonROV.com

## Specifications

Weight in Air	.....	2.6Kg
Weight in Sea water	.....	0.6Kg

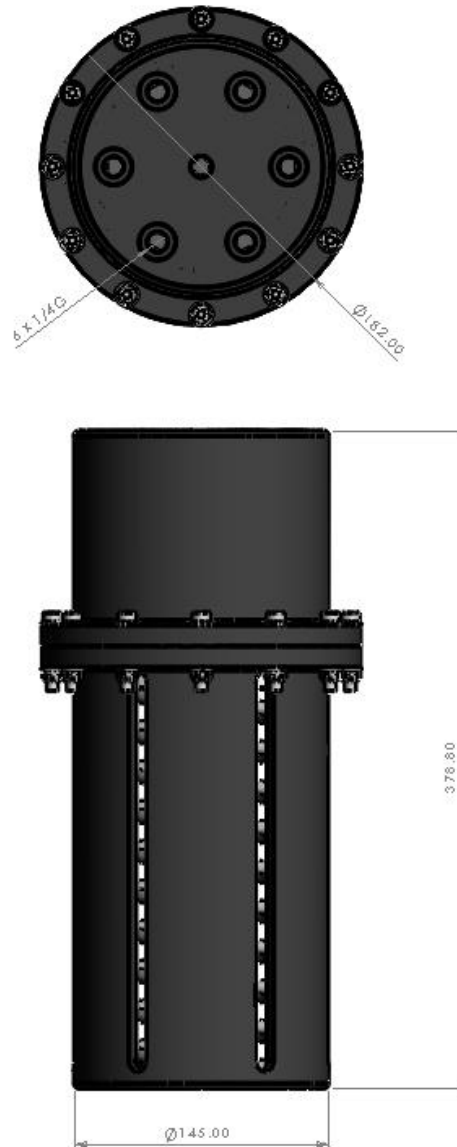

## Options

- Aluminium, Stainless steel, and duplex versions available

Information contained in this data sheet is up-to-date and correct as at the date of issue. All product designs, specifications and data are subject to change without notice to improve reliability, function, design or otherwise. No express or implied warranties are given.